

REACH & RoHS  
COMPLIANT

REV.	ECN / DESCRIPTION	BY	DATE
A0	NEW	ZG.HU	2018.06.11
A1	Cancel the notch in shield 蔽壳取消缺口	ZG.HU	2023.10.31

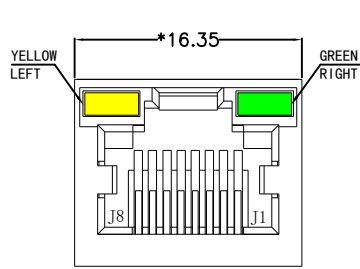

FRONT VIEW

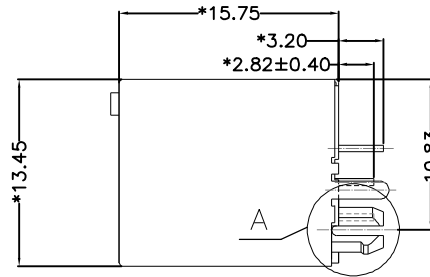

RIGHT SIDE VIEW

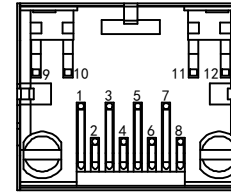

BACK VIEW

**MATERIAL:**

HOUSING: PBT,UL94V-0,BLACK.  
TERMINAL: PHOSPHOR BRONZE  $\phi=0.46$ MM,  
G/FU" GOLD PLATING.  
SHIELD: C2680,T=0.20MM,20 MIN NICKEL PLATING  
ON ALL AREA.

**MACHANICAL:**

DURABILITY: 750 CYCLES MIN,12.5MM/MINUTE.  
INSERTION FORCE: 2.2KG.F MAX.  
RETENTION STRENGTH : 7.7KG.F BETWEEN JACK AND PLUG.  
OPERATING TEMPERATURE: -40°C~+85°C.  
STORAGE TEMPERATURE: -40°C~+85°C.  
ALL CRITICAL DIMENSIONS WITH "\*"

**ELECTRICAL:**

VOLTAGE: 125 VOLTS AC.  
CURRENT RATING : 1.5AMP.  
DIELECTRIC STRENGTH: 1000 VAC RMS 50HZ OR 60HZ,1MIN.  
INSULATION RESISTANCE: 500 MEGA OHMS MIN. INITIAL  
AFTER 500V DC FOR 1 MINUTE.  
CONTACT RESISTANCE: SINGLE TERMINAL 30 MILLIOHMS MAX.  
INITIAL 50 MILLIOHMS MAX. AFTER  
DURABILITY TEST.

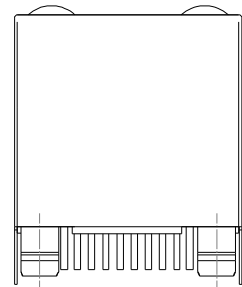

BOTTOM VIEW

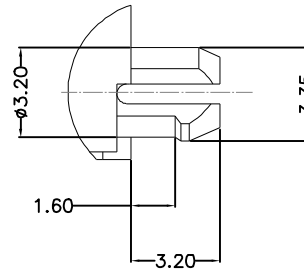

A(2:1)

**LED Specification**

Standard LED Color	LED Wavelength	Foward(A)	Foward(V)
Green	568nm	20mA	1.85-2.45V
Yellow	585nm	20mA	1.7-2.2V

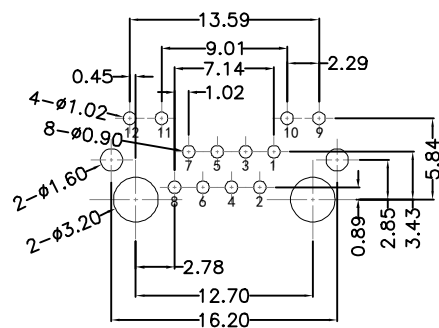

RECOMMENDED PCB LAYOUT  
VIEWED FROM COMPONENT SIDE

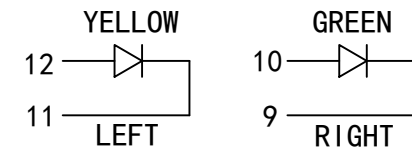
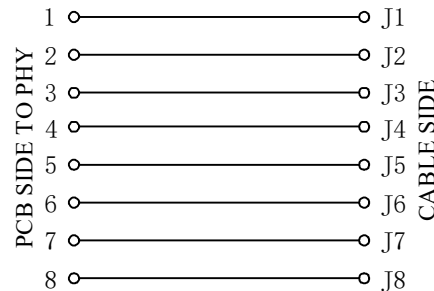

**DGKYD**

东莞市科优达电子科技有限公司  
Dong Guan Ke You Da Electronic Tech.Co.,Ltd

ADD :No.1 LiHe Street,LiHeng Village,Qingxi town, DongGuan City,GuangDong Province  
Tel:+86-0769-87334608; Fax:+86-0769-87847129 WWW.DGKYD.COM

TITLE: 52T 1X1 8P8C 带灯带屏蔽	SIZE A4	UNITS MM[INCH]	GENERAL TOLERANCES UNLESS SPECIFIED		APPROVED BY: JP.Gong
PART NO.: DGKYD52T1188AB1A1DY1	SACLE 1:1	REV A1	x±0.35	x°±3.0°	CHECKED BY: TW.Xu
REMARK:	SHEET 1/1		.xx±0.25	.xx°±1.5°	DESIGND BY: ZG.Hu
			.xxx±0.10	.xxx°±1.0°	